



samlexpower

**120 Watt
DC-AC Inverter
Pure Sine Wave**

PST-12S-12A

**Owner's
Manual**

Please read
this manual
before
using your
inverter

1

INTRODUCTION

Thank you for choosing to purchase our inverters. Our power inverter series are designed to be your best companion at home, in the office, when travelling, outdoor camping, at sea, etc.

This power inverter has a rated output of 120 Watts.

The inverter series can be used to operate laptops, portable electronics, most small TVs, VCRs, sound systems and small handy tools, and other portable sensitive electronic products.

GENERAL SAFETY

- Read this General Safety, installation, and Operation Guidelines carefully before using your inverter and strictly follow the instructions.
- Keep away from children.
- Never attempt to operate the inverter from any power source other than a 12V battery.
- Make sure that the power consumption of the appliance or equipment you wish to operate is compatible with the capacity of the inverter.
- When operating the inverter with a car or marine battery, start the engine every 30 to 60 minutes and let it run for approximately 10 minutes to recharge the battery.
- Do not use the inverter near any flammable gases or liquid.
- Do not expose the inverter to moisture.
- Avoid placing inverter near sources of heat or under direct sunlight.
- Make sure **inverter is well ventilated during use. Keep a clear space of 10 cm around the inverter.(Fig. 4)**
- Remove the inverter from the cigarette lighter socket when not in use.

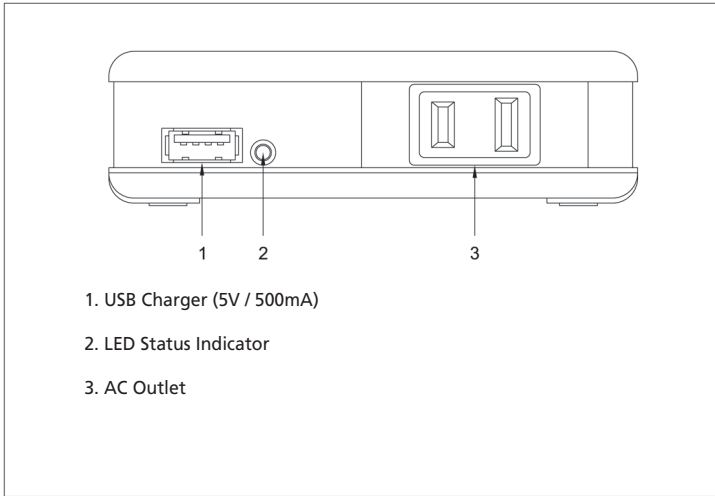

Fig. 1 - Front view

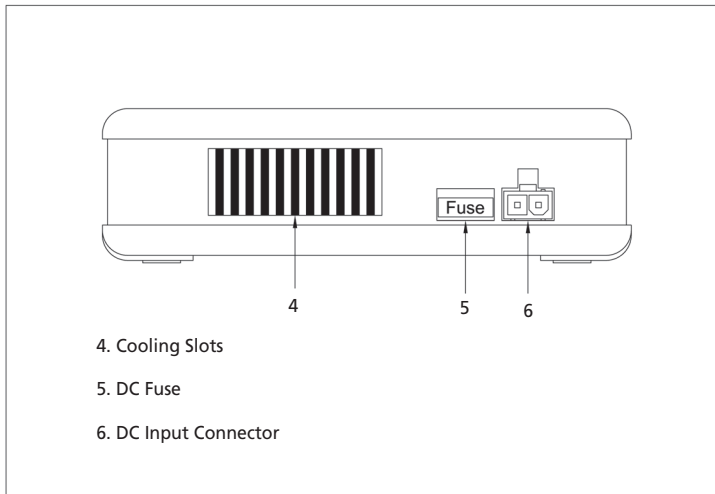

Fig. 2 - Rear view

2

DESCRIPTIONS

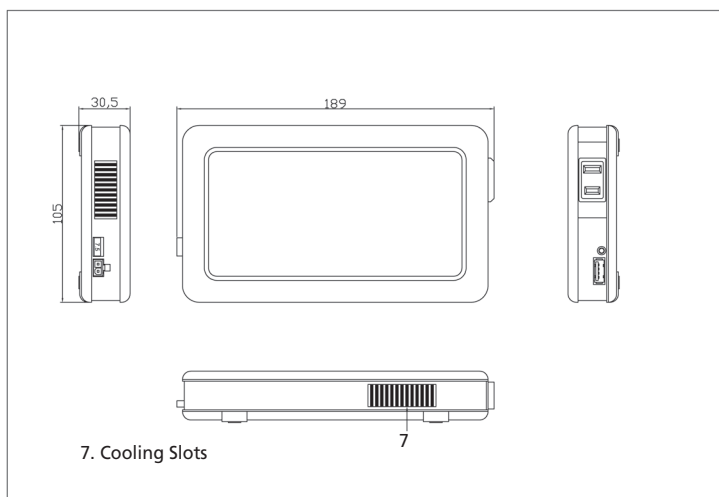

Fig. 3 - Plan, elevations & dimensions

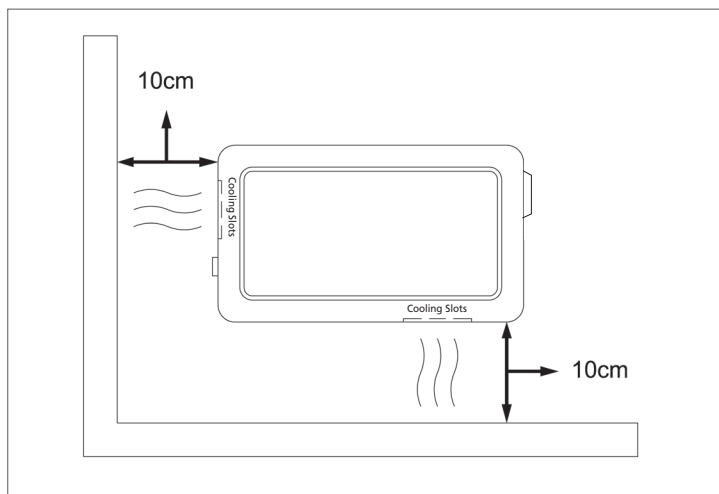

Fig. 4 - Installation clearances for installation

Connect the DC Input Wire to the DC Input Connector.⁽⁶⁾

Plug in the cigarette lighter plug of the DC Input Wire into the cigarette lighter socket.

When the LED Status Indicator⁽²⁾ light is green, the inverter's AC Outlet⁽³⁾ and USB port⁽¹⁾ will have voltage outputs.

Insert plug of your electrical appliance into the AC Outlet⁽³⁾ of the inverter.

Remove the inverter from the cigarette lighter socket when not in use.

The inverter is protected against the following abnormal conditions and will shut down under these conditions:

- Overload & short circuit on the output side
- Over temperature due to fan failure or due to lack of cool replacement air
- Low DC input voltage
- High DC input voltage

The inverter will automatically reset when the abnormal condition is removed.

The status of operation of the inverter is indicated by the LED Status indicator⁽²⁾ as given below:

LED Status	Inverter & USB Status Indicated	
The LED is OFF	Fuse blown or no USB power	
Green Light	Inverter & USB normal	
Orange Light	Inverter shutdown*	USB normal
Red Light	Inverter shutdown*	No USB power



*Inverter shutdown: Over Temperature, Over Voltage & Low Voltage

Cooling

The inverter has a fan for cooling. It is temperature controlled and will come on once the temperature of the hot spot inside the unit exceeds a preset temperature. Hence, the fan may not be on all the time. Place the unit in a cool, well ventilated space that has adequate cool replacement air (see Fig. 4).

3

TECHNICAL SPECIFICATIONS

Parameter	PST-12S-12A
Output Power: Continuous:	120W
Output Voltage:	120V+/-3%
Output Frequency:	60Hz +/-1%
Output Wave Form:	Pure Sine Wave
Total Harmonic Distortion:	< 3%
Input Voltage Range:	10V~16.5V
Maximum efficiency:	88%
No Load Current :	<0.5 A
Input current, maximum:	15A
Low Battery Shut-Down:	10V
Dimension (L x W x H)	190x105x30mm
Inverter Weight :	453g
Fan	Temperature Controlled
USB Power	5V +/-0.1V /500mA
Protections	Low input voltage High input voltage Overload Short circuit
SAFETY :	EN 60950-1
E Mark :	 10R-03 9956
EMC :	EN 55022 : 2006 EN 61000-3-2 : 2006 EN 61000-3-3 : 1995+A1 : 2001+A2 : 2005 EN 55024 : 1998+A1 : 2001+A2 : 2003
	 

4 WARRANTY

The PST-12S-12A Inverter supplied by Samlex America, Inc. (the "Warrantor") is warranted to be free from defects in workmanship and materials under normal use and service. This warranty is in effect for 2 years from the date of purchase by the user (the "Purchaser").

For a warranty claim, the Purchaser should contact the place of purchase to obtain a Return Authorization Number. The defective part or unit should be returned at the Purchaser's expense to the authorized location. A written statement describing the nature of the defect, the date of purchase, the place of purchase, and the Purchaser's name, address and telephone number should also be included. If upon the Warrantor's examination, the defect proves to be the result of defective material or workmanship, the equipment will be repaired or replaced at the Warrantor's option without charge, and returned to the Purchaser at the Warrantor's expense.

No refund of the purchase price will be granted to the Purchaser, unless the Warrantor is unable to remedy the defect after having a reasonable number of opportunities to do so. Warranty service shall be performed only by the Warrantor. Any attempt to remedy the defect by anyone other than the Warrantor shall render this warranty void. There shall be no warranty for defects or damages caused by faulty installation or hook-up, abuse or misuse of the equipment including exposure to excessive heat, salt or fresh water spray, or water immersion.

No other express warranty is hereby given and there are no warranties which extend beyond those described herein. This warranty is expressly in lieu of any other expressed or implied warranties, including any implied warranty of merchantability, fitness for the ordinary purposes for which such goods are used, or fitness for a particular purpose, or any other obligations on the part of the Warrantor or its employees and representatives.

DISCLAIMER OF LIABILITY

There shall be no responsibility or liability whatsoever on the part of the Warrantor or its employees and representatives for injury to any persons, or damage to person or persons, or damage to property, or loss of income or profit, or any other consequential or resulting damage which may be claimed to have been incurred through the use or sale of the equipment, including any possible failure of malfunction of the equipment, or part thereof.

The Warrantor assumes no liability for incidental or consequential damages of any kind.

Samlex America Inc. (the "Warrantor")
110-17 Fawcett Road
Coquitlam BC V3K6V2 Canada
(604) 525-3836



samlexpower

110-17 Fawcett Rd
Coquitlam, B.C.
Canada V3K 6V2

T: 604 525 3836
F: 604 525 5221

e-mail: samlex@samlexamerica.com
website: www.samlexamerica.com